



CD Transport



MCD1000 Owner's Manual

The lightning flash with arrowhead, within an equilateral triangle, is intended to alert the user to the presence of uninsulated "dangerous voltage" within the product's enclosure that may be of sufficient magnitude to constitute a risk of electric shock to persons.



AVIS RISQUE DE CHOC ELECTRIQUE - NE PAS OUVRIR.

The exclamation point within an equilateral triangle is intended to alert the user to the presence of important operating and maintenance (servicing) instructions in the literature accompanying the appliance.

WARNING - TO REDUCE RISK OF FIRE OR ELECTRICAL SHOCK, DO NOT EXPOSE THIS EQUIPMENT TO RAIN OR MOISTURE.

NO USER-SERVICEABLE PARTS INSIDE. REFER SERVICING TO QUALIFIED PERSONNEL.

To prevent the risk of electric shock, do not remove cover or back. No user serviceable parts inside.

CAUTION - Invisible Laser Radiation when open. DO NOT stare into the beam or view directly with optical instruments. Use of controls or adjustment or performance of procedures other than those specified in the Owners Manual may result in Hazardous Radiation Exposure.

LUOKAN 1 LASERLAITE KLASS 1 LASER APPARAT

VAROITUS! Laitteen käyttäminen muulla kuin tassa kayttoohjeessa mainitulla tavalla saattaa altistaa käyttäjän turvallisuusluokan 1 ylittävälle näkymättömälle lasersäteilylle.

VARNING! Om apparaten används på annat sätt än i denna bruksanvisning specificerats, kan användaren utsättas för osynlig laserstrålning, som överskrider gränsen för laserklass 1.

This product incorporates an embedded **CLASS 1 Laser (CFR).**

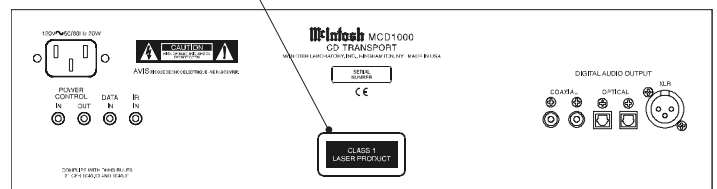
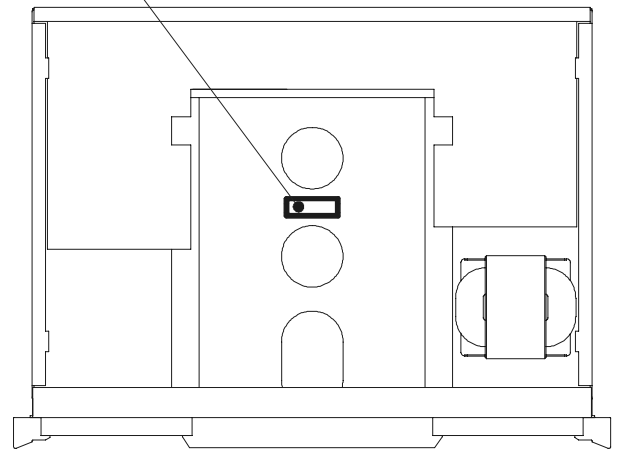
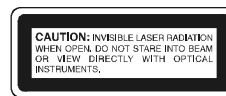

IMPORTANT SAFETY INSTRUCTIONS!

PLEASE READ THEM BEFORE OPERATING THIS EQUIPMENT.

1. Read these instructions.
2. Keep these instructions.
3. Heed all warnings.
4. Follow all instructions.
5. Do not use this apparatus near water.
6. Clean only with a dry cloth.
7. Do not block any ventilation openings. Install in accordance with the manufacturer's instructions.
8. Do not install near any heat sources such as radiators, heat registers, stoves, or other apparatus (including amplifiers) that produce heat.
9. Do not defeat the safety purpose of the polarized or grounding-type plug. A polarized plug has two blades with one wider than the other. A grounding type plug has two blades and a third grounding prong. The wide blade or the third prong are provided for your safety. If the provided plug does not fit into your outlet, consult an electrician for replacement of the obsolete outlet.
10. Protect the power cord from being walked on or pinched particularly at plugs, convenience receptacles, and the point where they exit from the apparatus.
11. Only use attachments/accessories specified by the manufacturer.
12. Use only with the cart, stand, tripod, bracket, or table specified by the manufacturer, or sold with the apparatus. When a cart is used, use caution when moving the cart/apparatus combination to avoid injury from tip-over. 
13. Unplug this apparatus during lightning storms or when unused for long periods of time.
14. Refer all servicing to qualified service personnel. Servicing is required when the apparatus has been damaged in any way, such as power-supply cord or plug is damaged, liquid has been spilled or objects have fallen into the apparatus, the apparatus has been exposed to rain or moisture, does not operate normally, or has been dropped.
15. Do not expose this equipment to dripping or splashing and ensure that no objects filled with liquids, such as vases, are placed on the equipment.
16. To completely disconnect this equipment from the a.c. mains, disconnect the power supply cord plug from the a.c. receptacle.
17. The mains plug of the power supply cord shall remain readily operable.

McIntosh

Thank You

Your decision to own this McIntosh MCD1000 CD Transport ranks you at the very top among discriminating music listeners. You now have “The Best.” The McIntosh dedication to “Quality,” is assurance that you will receive many years of musical enjoyment from this unit.

Please take a short time to read the information in this manual. We want you to be as familiar as possible with all the features and functions of your new McIntosh.

Please Take A Moment

The serial number, purchase date and McIntosh Dealer name are important to you for possible insurance claim or future service. The spaces below have been provided for you to record that information:

Serial Number: _____

Purchase Date: _____

Dealer Name: _____

Technical Assistance

If at any time you have questions about your McIntosh product, contact your McIntosh Dealer who is familiar with your McIntosh equipment and any other brands that may be part of your system. If you or your Dealer wish additional help concerning a suspected problem, you can receive technical assistance for all McIntosh products at:

McIntosh Laboratory, Inc.
2 Chambers Street
Binghamton, New York 13903
Phone: 607-723-1545
Fax: 607-723-3636

Customer Service

If it is determined that your McIntosh product is in need of repair, you can return it to your Dealer. You can also return it to the McIntosh Laboratory Service Department. For assistance on factory repair return procedure, contact the McIntosh Service Department at:

McIntosh Laboratory, Inc.
2 Chambers Street
Binghamton, New York 13903
Phone: 607-723-3515
Fax: 607-723-1917

Table of Contents

Safety Instructions	2
Thank You and Please Take a Moment	4
Technical Assistance and Customer Service	4
Table of Contents	4
Important Information	4
Connector Information	5
Introduction	5
Performance Features	5
Dimensions	6
Installation	7
Rear Panel Connections	8
How to Connect	9
Front Panel Indicator, Push-buttons and Switch	10
Front Panel Display	11
Remote Control Push-buttons	12
How to Operate the Remote Control	13
How to Operate the MCD1000	14
Specifications	22
Packing Instructions	23

Important Information

- 1. It is recommended that a qualified professional assist you in the choice and installation of a McIntosh Audio System for your home.*
- 2. Before making any connections to the MCD1000, make sure that the Main POWER Switch is in the Off position. When the MCD1000 and other McIntosh Components are in their Standby Mode the Microprocessor's Circuitry inside each component is active and communication is occurring between them. Failure to do so could result in malfunctioning of some or all of the system's normal operations.*
- 3. The following Connecting Cable is available from the McIntosh Parts Department:
Data and Power Control Cable Part No. 170-202
Six foot, 2 conductor shielded, with two 1/8 inch stereo mini phone plugs.*
- 4. When the MCD1000 Digital XLR Output is used to connect with the Digital XLR Input of the McIntosh MDA1000 D/A Converter, it is important to use a twisted pair shielded cable.*
- 5. For additional connection information, refer to the owner's manual(s) for any component(s) connected to the MCD1000.*
- 6. The MCD1000 basic transport functions may also be controlled by using the Remote Control that comes with a McIntosh Control Center or Preamplifier. McIntosh Keypads connected to a McIntosh Control Center or Preamplifier will also allow remote operation.*
- 7. Before moving or transporting the MCD1000 CD Transport remove any CD Disc from the tray to prevent possible damage to the Transport and/or Discs.*

8. The MCD1000 Compact Disc Player is designed to play all standard CD Discs that conform to the Official Compact Disc Standards which is indicated by the  Symbol. It will also play most CD-R discs, however some discs may not be able to play due to the condition of the recording.
9. Compact Discs that are not round (e.g. Novelty discs with octagonal or heart shapes) will not play properly in the MCD1000 and should not be tried, as possible damage may occur.
10. The following list of Compact Disc Accessories should not be used with the MCD1000:
 - A. Compact Disc Stabilizers.
 - B. Disc Protectors.
 - C. Lens/Laser Cleaning Discs and devices.

Connector Information

XLR Connectors:

Below is the Pin configuration for the XLR Balanced Digital Audio Output Connectors on the MCD1000. Refer to the diagram for connection:

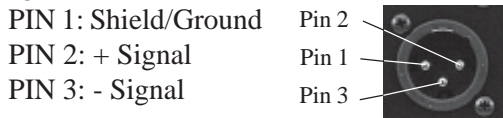

Power Control and Trigger Connectors

The MDA1000's Power Control Outputs provide a 5 volt signal. Use a 1/8 inch stereo mini phone plug to connect to the Power Control Input on other McIntosh Components.

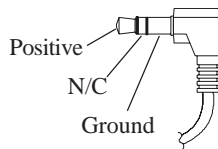

Data and IR Port Connectors

The MDA1000's Data Port Output provides Remote Control Signals and the IR Input Port allows for the connection of other brands IR Sensors. Use a 1/8 inch stereo mini phone plug to connect to the Data Port Inputs on McIntosh Source Units.

Data Port Connector

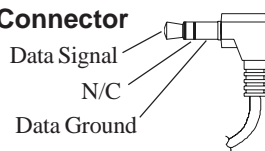

IR Input Port Connector

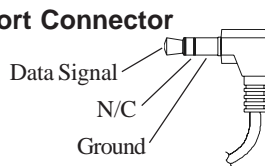

Introduction

The McIntosh MCD1000 CD Transport offers the latest in technology and provides state of the art reproduction of Compact Discs. A full complement of performance features together with the advanced mechanical design ensures many years of smooth trouble free operation.

Performance Features

● Advanced Transport

The MCD1000 has a custom designed precision-machined metal disc tray for safe and gentle disc handling. The servo-controlled transport with a shock resistant suspension incorporating the latest in error correction circuitry for reading imperfect discs.

● Four Playback Modes

The MCD1000 Compact Disc Player allows for Disc Playback, Intro Playback, Program Playback and Random Playback.

● Front Panel Display

The Display indicates the Disc, Track and Time information along with the Playback Mode in use.

● Remote Power, Data Control and External IR Input

Remote Power Control In/Out allows the MCD1000 to turn On/Off with a McIntosh Audio Control Center. The Data Port Input allows Remote Control Operation from another McIntosh Component. The IR Input allows for the connection of an IR Receiver.

● Special Power Supply

A fully regulated Power Supply with a special R-Core Power Transformer, ensures stable noise free operation even though the power line varies.

● Fiber Optic Solid State Front Panel Illumination

The Illumination of the Glass Front Panel, with a three dimensional look, is accomplished by the combination of custom designed Fiber Optic Light Diffusers and extra long life Light Emitting Diodes (LEDs). This provides even Front Panel Illumination and is designed to ensure the pristine beauty of the MCD1000 will be retained for many years.

● Machined Top and Side Panels

The Top and Side of the MCD1000 are machined from thick aluminum panels with a smooth black anodized finish. In the recessed area of the Top Panel is a screened glass panel with a block diagram of the MCD1000's circuitry.

Dimensions

The following dimensions can assist in determining the best location for your MCD1000. There is additional information on the next page pertaining to installing the MCD1000 into cabinets.

**Front View
of the
MCD1000**



**Rear View
of the
MCD1000**

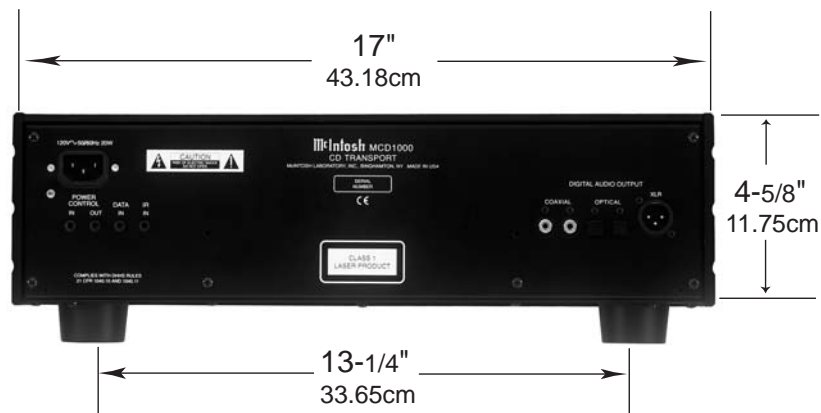

**Side View
of the
MCD1000**

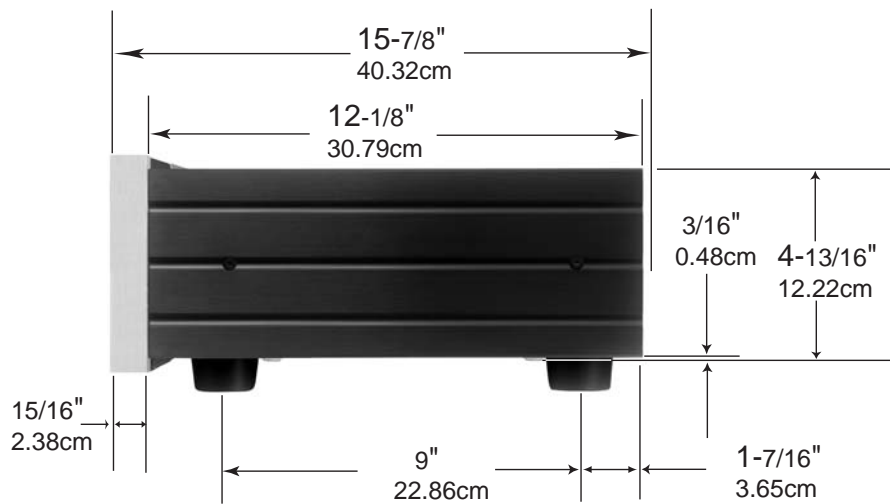

Installation

The MCD1000 can be placed upright on a table or shelf standing on its four feet. It also can be custom installed in a piece of furniture or cabinet of your choice. The four feet may be removed from the bottom of the MCD1000 when it is custom installed as outlined below. The four feet together with the mounting screws should be retained for possible future use if the MCD1000 is removed from the custom installation and used free standing. The required panel cutout, ventilation cutout and unit dimensions are shown.

Always provide adequate ventilation for your MCD1000. Cool operation ensures the longest possible operating life for any electronic instrument. Do not install the MCD1000 directly above a heat generating component such as a high powered amplifier. If all the components are installed in a single cabinet, a quiet running ventilation fan can be a definite asset in maintaining all the system components at the coolest possible operating temperature.

A custom cabinet installation should provide the following minimum spacing dimensions for cool operation. Allow at least 2 inches (5.08cm) above the top, 2 inches (5.08cm) below the bottom and 1 inch (2.54cm) on each side of the CD Transport, so that airflow is not obstructed. Allow 17 inches (43.18cm) depth behind the front panel. When a CD Disc is inserted or removed, the panel clearance required in front of the mounting panel is 3-3/4 inches (9.5cm). Be sure to cut out a ventilation hole in the mounting shelf according to the dimensions in the drawing.

Allow at least 2 inches (5.08cm) above the top, 2 inches (5.08cm) below the bottom and 1 inch (2.54cm) on each side of the CD Transport, so that airflow is not obstructed. Allow 17 inches (43.18cm) depth behind the front panel. When a CD Disc is inserted or removed, the panel clearance required in front of the mounting panel is 3-3/4 inches (9.5cm). Be sure to cut out a ventilation hole in the mounting shelf according to the dimensions in the drawing.

MCD1000 Front Panel Custom Cabinet Cutout



MCD1000 Side View in Custom Cabinet

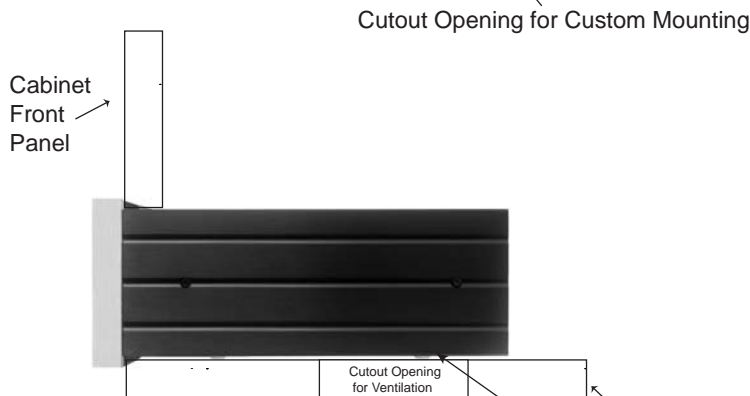

MCD1000 Bottom View in Custom Cabinet

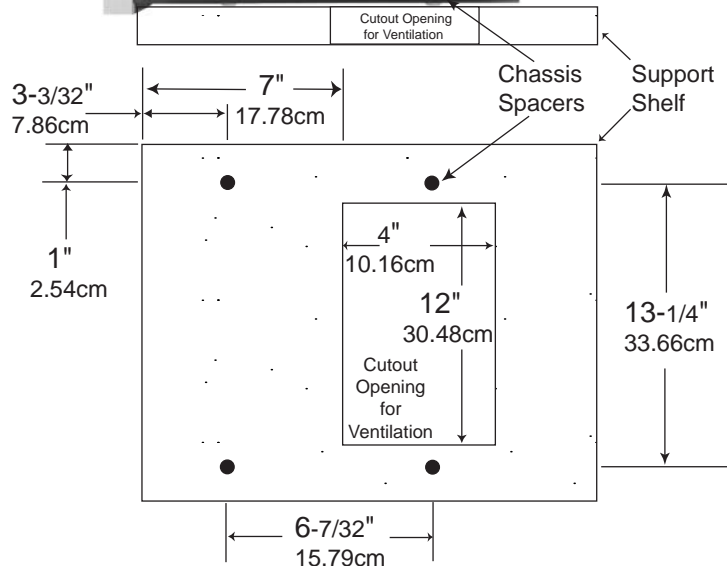

Connect the MCD1000 power cord to a live AC outlet. Refer to information on the back panel to determine the correct voltage

IR INPUT for connecting an IR Receiver

COAXIAL DIGITAL AUDIO OUTPUTS send digital audio signals to a D/A Converter

Balanced XLR DIGITAL AUDIO OUTPUT sends digital audio signals from the McIntosh MCD1000 CD Transport to the MDA1000 D/A Converter



DATA IN receives operating data from a McIntosh Control Center

OPTICAL DIGITAL AUDIO OUTPUTS sends digital audio signals to a D/A Converter

POWER CONTROL IN receives turn-On signals from a McIntosh Component and POWER CONTROL OUT sends turn-On signals on to another McIntosh Component

How to Connect

1. Connect a Power Control Cable from the MDA1000 Power Control Out Jack to the POWER CONTROL IN Jack on the McIntosh MCD1000.

Notes: 1. If the MCD1000 CD Transport is not connected to a McIntosh MDA1000 D/A Converter and instead connected to a McIntosh A/V Control Center with digital inputs, the MCD1000's Power Control In should be connected to the appropriate Power Control Out Jack on the A/V Control Center.

2. When the MCD1000 and MDA1000 are connected in a non-McIntosh Preamplifier System, the Power Control Cable should be connected from the MCD1000 Power Control Out to the MDA1000 Power Control In.

2. Connect a Data Control Cable from the MDA1000 Line 1 Switched Data Output Jack to DATA IN Port on the McIntosh MCD1000.

Note: If the MCD1000 CD Transport is not connected to a McIntosh MDA1000 D/A Converter and instead connected to a McIntosh A/V Control Center with digital inputs, the MCD1000's Data In should be connected to the appropriate Data Out Jack on the A/V Control Center.

3. Connect a Coaxial Digital Cable from the MDA1000 Coaxial 1 Digital Audio Input to either COAXIAL DIGITAL AUDIO OUTPUT Jack on the MCD1000.

Note: When the MCD1000 CD Transport is connected to a McIntosh MDA1000 D/A Converter the Digital Optical Output or the Balanced Digital XRL Output may be used instead of the Coaxial Digital Output. If MCD1000 CD Transport is connected to a McIntosh A/V Control Center with digital inputs either the Coaxial or Optical Outputs may be used.

4. Connect the MCD1000 Power Cord to a live AC outlet.

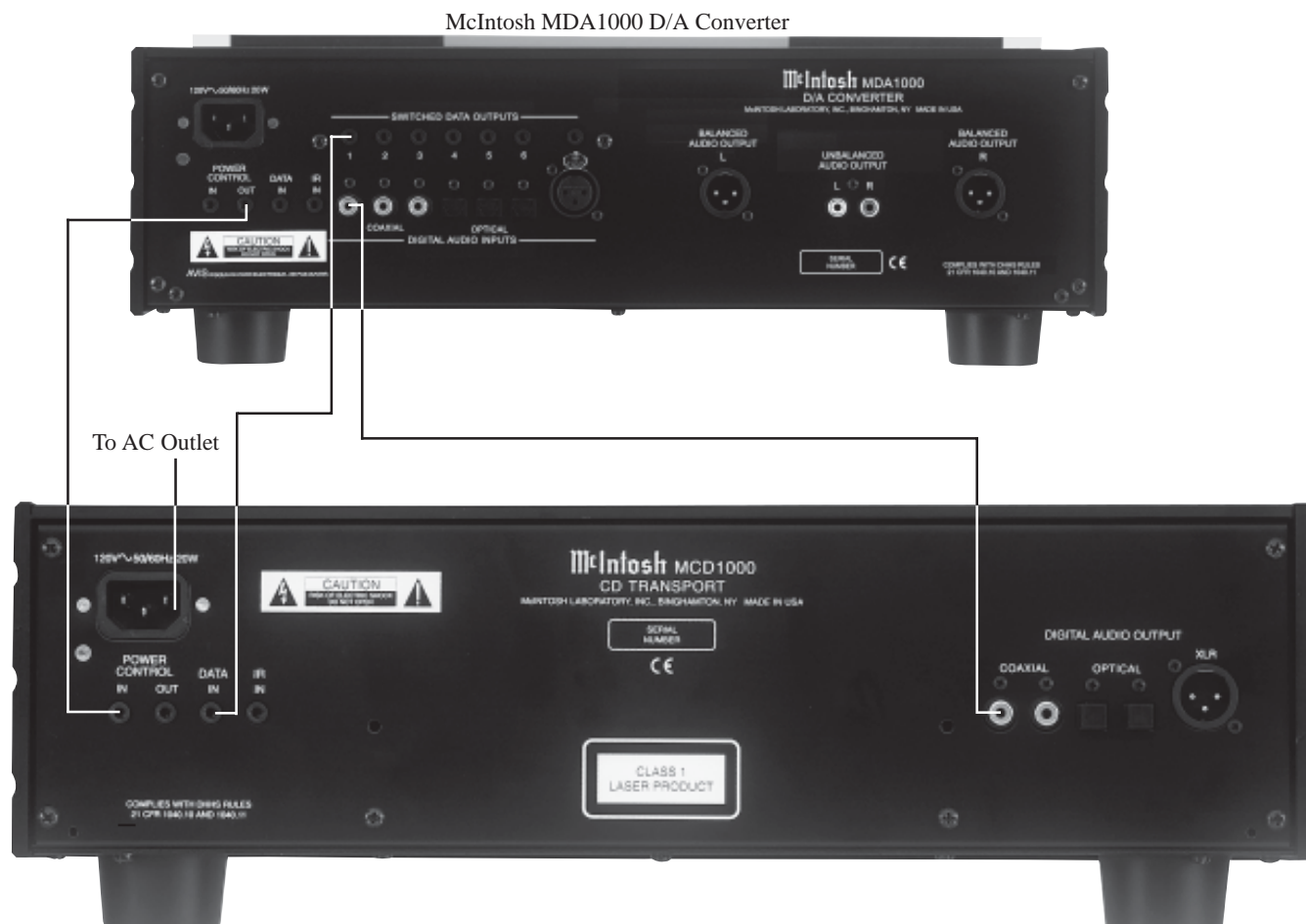

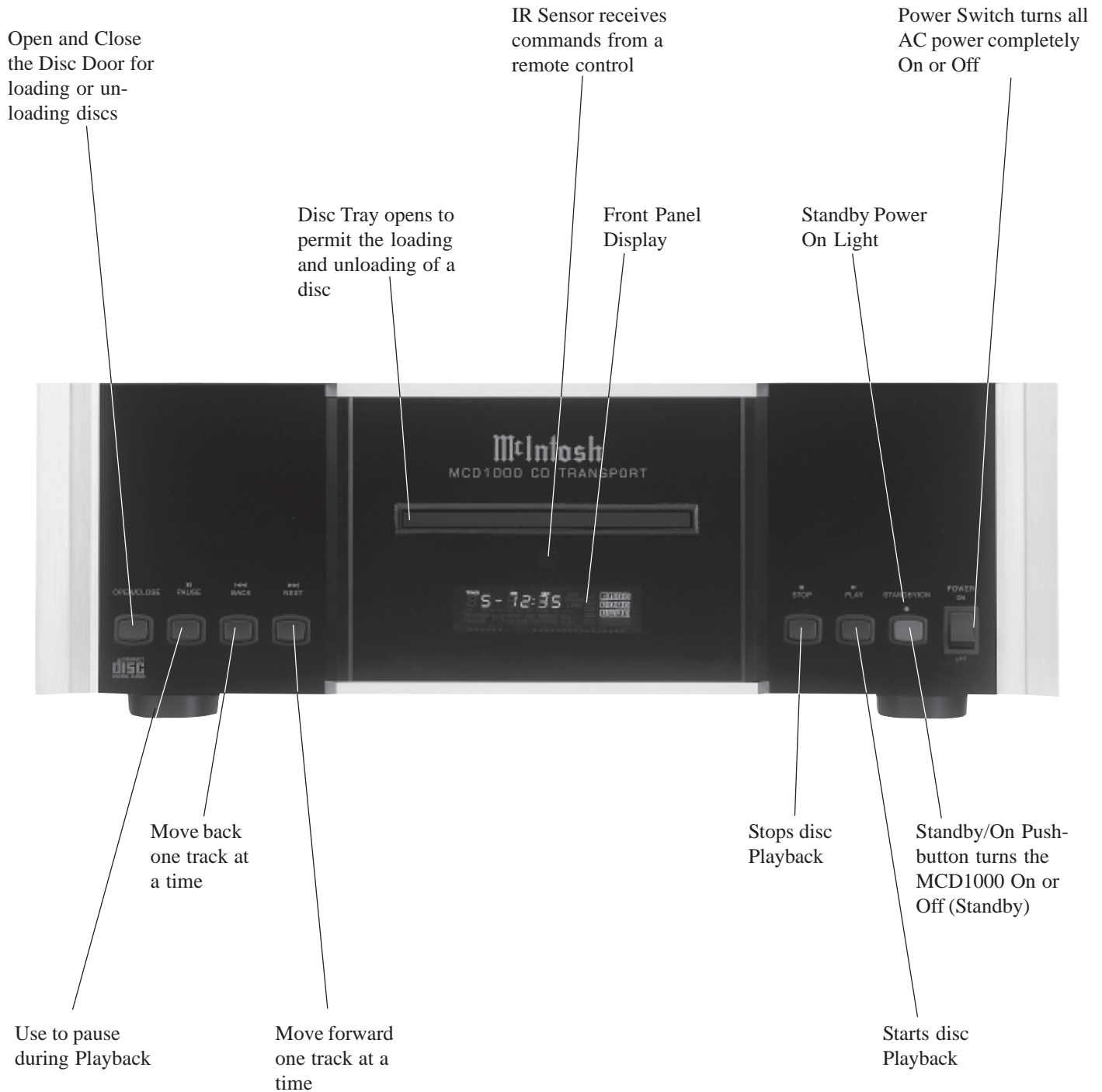

Indicates the Program Track Play Mode is active

Indicates Track Number

Indicates the current Track Time, Remaining Track Time, Total Disc Playing Time and various Programming information

Indicates the Number of Tracks and the Total Playing Time of the Disc when the player is stopped

Indicates the number of tracks on the disc and the Program Step Number(s)

Indicates when the Time Display is showing the Remaining Time



Indicates the Random Track Play Mode is active

Indicates when in the Pause Mode

Indicates when the first ten seconds of each track is being played

Indicates when in the Play Mode

Indicates when the Repeat All Play Mode is active

Indicates when the A-B Repeat Play Mode is active

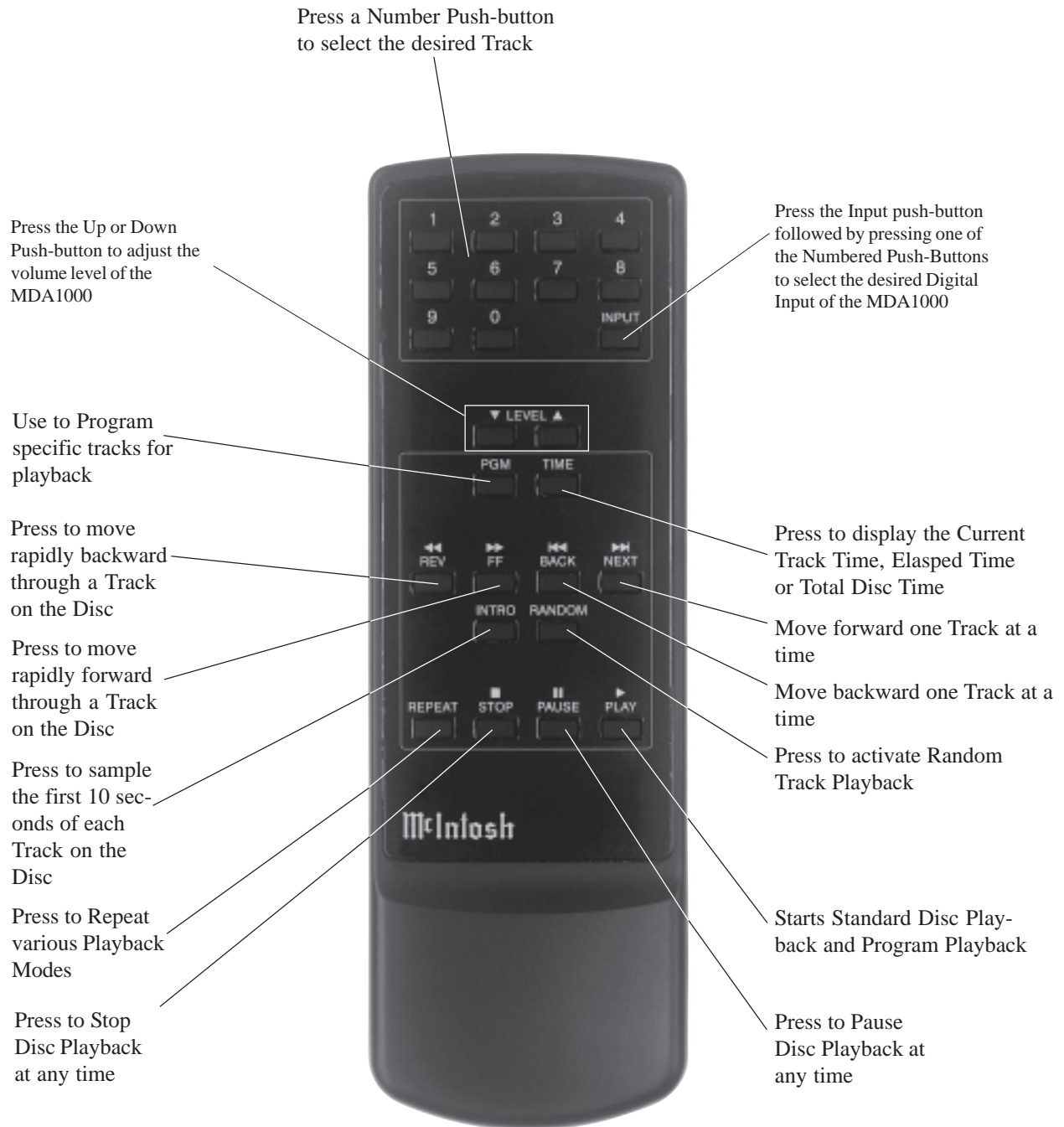

Notes: The Remote Control illustrated above is supplied with the matching MDA1000 D/A Converter. It is also available as an accessory for the MCD1000, check with your McIntosh Dealer for additional details. The buttons with the "small text descriptions" are used to control various functions of the McIntosh MDA1000 D/A Converter.

How to Operate the Remote Control

Numbered Push-buttons

Press a NUMBER Push-button (1 through 9) followed by pressing the PLAY Push-button to directly access the desired disc track. Track numbers above 9 require the pressing of two NUMBER Push-buttons. If the desired Track Number is higher than 9, first press and hold down the NUMBER Push-button until the number entered shifts its position to the "Tens Digit", as indicated on the Front Panel Alphanumeric Display, followed by pressing the NUMBER Push-button for the "Units Digit".

Program

The PGM(Program) Push-button is used to enter desired Track Selections into memory for Playback. Refer to page 17 for additional information on Programming.

Intro

Press the INTRO Push-button to audition the first 10 seconds of each track on the CD Disc.

Random

Press the RANDOM Push-button to playback Tracks in a random order.

Repeat

Press the REPEAT Push-button to allow continuous playback of Standard Play Mode, Random Play Mode or Program Play Mode.

Play

Press the PLAY Push-button to start Playback of the currently selected disc or a stored Program.

Time

During standard Disc Playback, pressing the TIME Push-button will allow the Front Panel Alphanumeric Display to indicate either the Current Track Time, Track Elapsed Time, Track Remaining Time, Disc Elapsed Time, Disk Remaining Time or only the Track Number.

Note: These five Track/Time Display Modes are not available during Intro Play Mode, Random Play Mode and Program Playback.

Pause

Press the PAUSE Push-button to momentarily stop Playback operation at any time. Press the PLAY Push-button to resume Playback of the disc.

Back and Next

Press the NEXT Push-button to move forward or the BACK Push-button to move backward one track at a time.

REV and FF

Press the REVERSE Push-button or FF(Fast Forward) Push-button to start moving rapidly through a track.

Note: Audio level is automatically reduced during this operating mode.

Stop

Press the STOP Push-button to stop the disc playing.

Alternate Remote Control Push-button Functions

Most basic MCD1000 Operating Functions can be performed with Remote Controls of McIntosh A/V Controllers, A/V Control Centers or Preamplifiers and McIntosh Keypads. Additional MCD1000 functions can be performed with other McIntosh Remote Controls by using push-buttons that are labeled differently from the Compact Disc Remote Control. The chart below lists the MCD1000 operations that can be performed by these different pushbuttons on Remote Controls of other McIntosh products.

Other McIntosh Remote Control Devices				
MCD1000 Function	A/V Control Center	WK2 Keypad	WK3 Keypad	WK4 Keypad
Play	Play	Play	Play	Play
Stop	Stop	Stop	Stop	Stop
Pause	Pause	-	-	-
Next	Next	Next	Next	Next
Back	Back	Back	-	Back
Fast Forward	Fast Forward	Seek Up	-	Channel Up
Fast Reverse	Fast Reverse	Seek Down	-	Channel Down
Numbers 0-9	Numbers 0-9	Numbers 0-9	-	Numbers 0-9

How to Operate the MCD1000

Press the POWER switch to ON, the Red LED above the STANDBY/ON Push-button lights to indicate the MCD1000 is in Standby Mode. To Switch On the MCD1000 press the STANDBY/ON Push-button. With no CD Disc loaded in the CD Transport the Front Panel Alphanumeric Display will indicate "Track 0" Refer to figures 1 and 8.

Notes: For normal operation, switch the MCD1000 On and Off with the Standby/On Push-button. If the Disc Player is not going to be used for an extended period of time, turn Off all AC Power with the Power Switch. When the MCD1000 Power Control Jack is connected (via a cable) to a McIntosh MDA1000 D/A Converter, Control Center, A/V Multizone System Controller or Preamplifier, the MCD1000 will automatically switch ON and OFF with the system. When power is first applied, the MCD1000 will determine if a disc is present inside and during that time the OPEN/CLOSE Push-button is not active until a triangle appears on the Alphanumeric Display.



Figure 1

Loading a Compact Disc

Before inserting a disc into the MCD1000 CD Transport please read Important Notes Numbers 8, 9 and 10 found on page 5 for important information.

1. Press the Front Panel OPEN/CLOSE Push-button and the Disc Loading Tray will slide open to permit the insertion of a Disc into the MCD1000. Refer to figures 2 and 8.



Figure 2

2. Insert the disc into the Disc Tray and press the Front Panel OPEN/CLOSE Push-button and the Disc Load-

ing Tray will draw the Disc into the Transport. Refer to figure 3.



Figure 3

Note: The Disc Tray will also close by giving the front edge of the tray a nudge, refer to figure 4.



Figure 4

3. The Front Panel Alphanumeric Display will indicate the number of Tracks and the Total playing time. Refer to figure 5.



Figure 5

4. Press the PLAY Push-button to start playback of the disc.

Unloading Compact Discs

The steps for removing the disc from the MCD1000 CD

Transport is similar to the Loading Disc Process, except in reverse.

1. Press the Front Panel STOP Push-button if a Disc is playing.
2. Press the OPEN/CLOSE Push-button and the Disc Loading Tray will slide open to permit removal of the Disc from the MCD1000 CD Transport.

Disc Playback

Press the PLAY ► Push-button and the disc will start playing. The Front Panel Display will indicate the current Track Number, the Time into the Track and a Triangle. When all of the tracks on the disc have played the MCD1000 will stop, unless the Repeat Playback Mode has been activated. Refer to figure 6.



Figure 6

Direct Track Selection

To select a specific track on a Compact Disc perform the following using a McIntosh Remote Control.

1. Press the NUMBER Push-button to select the desired Track.
Note: If the desired Track Number is higher than 9, first press and hold down the NUMBER Push-button until the number entered shifts its position to the "Tens Digit" followed by pressing the NUMBER Push-button for the "Units Digit". Refer to figure 7.

Disc Pause

While a Disc is playing, press the PAUSE ■ Push-button to temporarily stop playback. To cancel the Pause Mode, press the PLAY Push-button or press the PAUSE Push-button again and the disc will resume playing. The Front Panel



Figure 7

Display will indicate that the MCD1000 is in Pause Mode with double vertical rectangles positioned to the right of the Play Triangle. Refer to figure 9.



Figure 9

Stop Mode

Press the STOP ■ Push-button at any time to stop Disc Playback. If the MCD1000 is in Random, Intro and/or Program Modes of Playback, pressing the STOP Push-button will stop playing the disc and cancel the Random, Intro and/or Program Modes of Playback. Refer to figure 8.

Back Track

Pressing the BACK ◀◀ Push-button while a Disc is playing will either return playback to the beginning of the same Track or to the previous Track. If the push-button is pushed once, playback of the current track will start playing. When the push-button is pushed twice, the previous track will start playing. Holding down the push-button will allow for rapid selection of the desired Track.

Next Track

For each press of the NEXT ▶▶ Push-button the MCD1000 will advance to the next Track. Holding down the push-button will allow for rapid selection of the desired Track.



Figure 8

Important Operational Information

The optional MDA1000 Remote Control is needed to perform the following Operation Functions:

Fast Forward or Reverse

Press the FF (Fast Forward)▶▶ or REV (Reverse)◀◀ Push-buttons to move back and forth rapidly through the Track currently playing on a disc. The accelerated sound will be audible during this operation, at a reduced volume level. Releasing the push-button will return playback to normal speed and volume level.

Track and Time Display

The Front Panel Display can indicate five different Disc/Track Time Displays; Track Elapsed Time, Track Remain-



Figure 10



Figure 11



Figure 12



Figure 13



Figure 14

ing Time, Disc Elapsed Time, Disk Remaining Time and only the Track Number. With each press of the TIME Push-button on the Remote Control, the Front Panel Alphanumeric Display will indicate one of the five different displays. Refer to figures 10 thru 14.

Intro Play Mode

The Introduction Playback Mode when activated, allows for listening to the first 10 seconds of each track on the CD. To start the Intro Playback Mode, press the INTRO Push-button on the Remote Control. When the desired track is located, press the PLAY▶ Push-button on the Remote Control. This will restart the desired track from the beginning and cancel the Intro Playback Mode. Refer to figure 15.

Note: The Intro Playback Mode may be cancelled at any time by pressing the STOP Push-button.



Figure 15

Repeat Mode

This allows continuous playback of all the Tracks on the disc or a portion of a single track when the MCD1000 is in the Standard Play Mode. If either the Random and/or Program Modes of Playback are active, the Repeat Mode may also be activated for continuous playback of those Modes.

1. Press the REPEAT Push-button once to activate the Repeat Mode. The Front Panel Display will indicate the Repeat Mode is active. Refer to figure 16.



Figure 16

2. Press the REPEAT Push-button twice or the STOP Push-button to cancel the Repeat Mode.

A-B (Partial Track) Repeat Mode

1. Press the REPEAT Push-button once to activate the Repeat Mode and establish the "A - starting point", press the REPEAT Push-button again to set the "B - ending point". Refer to figure 17.

Note: The A-B Repeat Mode is intended for use within a single track.



Figure 17

2. Press the REPEAT Push-button twice or the STOP Push-button to cancel the Repeat Mode.

Random Play Mode

The MCD1000 CD Transport has the ability to playback Tracks in a random order during Standard Play Mode.

1. Press the RANDOM Push-button to activate the Random Play Mode.

Note: The Front Panel Alphanumeric Display of Pause "||" and "Track 1" indicators will momentarily illuminate while a Random Play List is being generated in memory. Refer to figure 18.



Figure 18

2. The Random Play Mode may be repeated by pressing the REPEAT Push-button after Random playback of



Figure 19

tracks has started. Refer to figure 19.

Note: While in the Random Play Mode, the next random track may be selected by pressing the NEXT ►►► Push-button or the previous random track by pressing the BACK ◄◄◄ Push-button.

3. To cancel the Random Play Mode press the STOP Push-button.

Program Playback

The MCD1000 has the ability to store up to 16 different Program Steps. This allows the playback of desired tracks in a specific order from the CD Disc. In order to program tracks from a disc, it is first necessary to read the the Table of Contents (TOC). The TOC contains the number of tracks

and time of each track for the CD disc. The reading of this information occurs when the Disc Loading Tray draws the Disc into the CD Transport.

1. Pressing the PGM (Program) Push-button on the Remote Control will activate the Programming Mode of the MCD1000 CD Transport. Refer to figure 20.



Figure 20

Note: The Front Panel Alphanumeric Display will indicate the Pause || Mode is active, three dashes appear under Track Number, the Time of the first Track on the Disc and the First Program Step Number "1" will be flashing.

2. Press the PAUSE || Push-button and the first track will start playing and the current memory location is available. Refer to figure 21



Figure 21

3. To enter this track into memory, press the PGM Push-button. If a different track is desired, use either the NEXT ►►► and BACK ◄◄◄ Push-buttons or the NUMBER (0 thru 9) Push-buttons to select the desired track and then press the PGM Push-button to enter it into memory. Refer to figure 22.

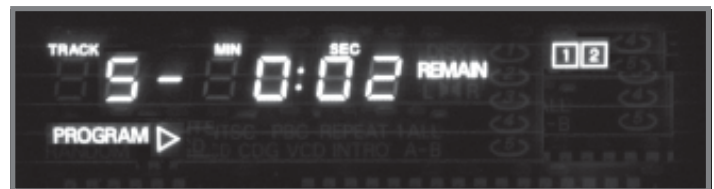

Figure 22

Note: The Front Panel Alphanumeric Display will momentarily indicate three dashes under the Track Number followed by the track number, the First Program Step Number "1" is now on continuously and a flashing Second Program Step Number "2" will appear.

4. Additional Track Selections may be entered into memory at this time by pressing the PGM Push-button and selecting the track using the NEXT ►►► and BACK ◄◄◄ Push-buttons or the NUMBER (0 thru 9).

The Front Panel Alphanumeric Display indicates that Program Steps “1” and “2” are on continuously and the next available Program Step will be flashing. Refer to figure 23.



Figure 23

5. To start playback of the just entered into memory Program Selections, press the PLAY▶ Pushbutton. Refer to figure 24.



Figure 24

Deleting a Program

The MCD1000 will keep an entered Program in its nonvolatile memory for Playback, even if AC Power is removed. To delete the Program stored in memory press the Front Panel OPEN/CLOSE Push-button.

Modify a Program

Sometimes after a Playback Program has been created, it might be desirable to make changes to the existing Program instead of deleting it and starting all over again.

Note: Changes to a program include the changing of any tracks currently entered into memory and adding new program steps to the end.

1. Press the PGM (Program) Push-button on the Remote Control to activate the Programing Mode on the MCD1000.
2. Press the PAUSE|| Push-button and the first track of the stored program will start playing.
3. To change the first program track use either the NEXT▶▶ and BACK◀◀ Push-buttons or the NUMBER (0 thru 9) Push-buttons to select the new track and then press the PGM Push-button to enter it into the current memory location.

Note: If the first program track selection doesn't need to be changed, just press the PGM Push-button and the second Program Step Location will become available for changing. Continue to press the PGM Push-button until the track to be changed is audible and perform step 3 to enter the new selection.

4. Add any new program steps by repeating step 3.
5. To start playback of the Program Selections just entered into memory, press the PLAY▶ Pushbutton.

Resetting of Microprocessors

In the event that the controls of the MCD1000 stop functioning, place the POWER Switch in the OFF position for 5 seconds, then back ON. This will reset the MCD1000 Microprocessors.

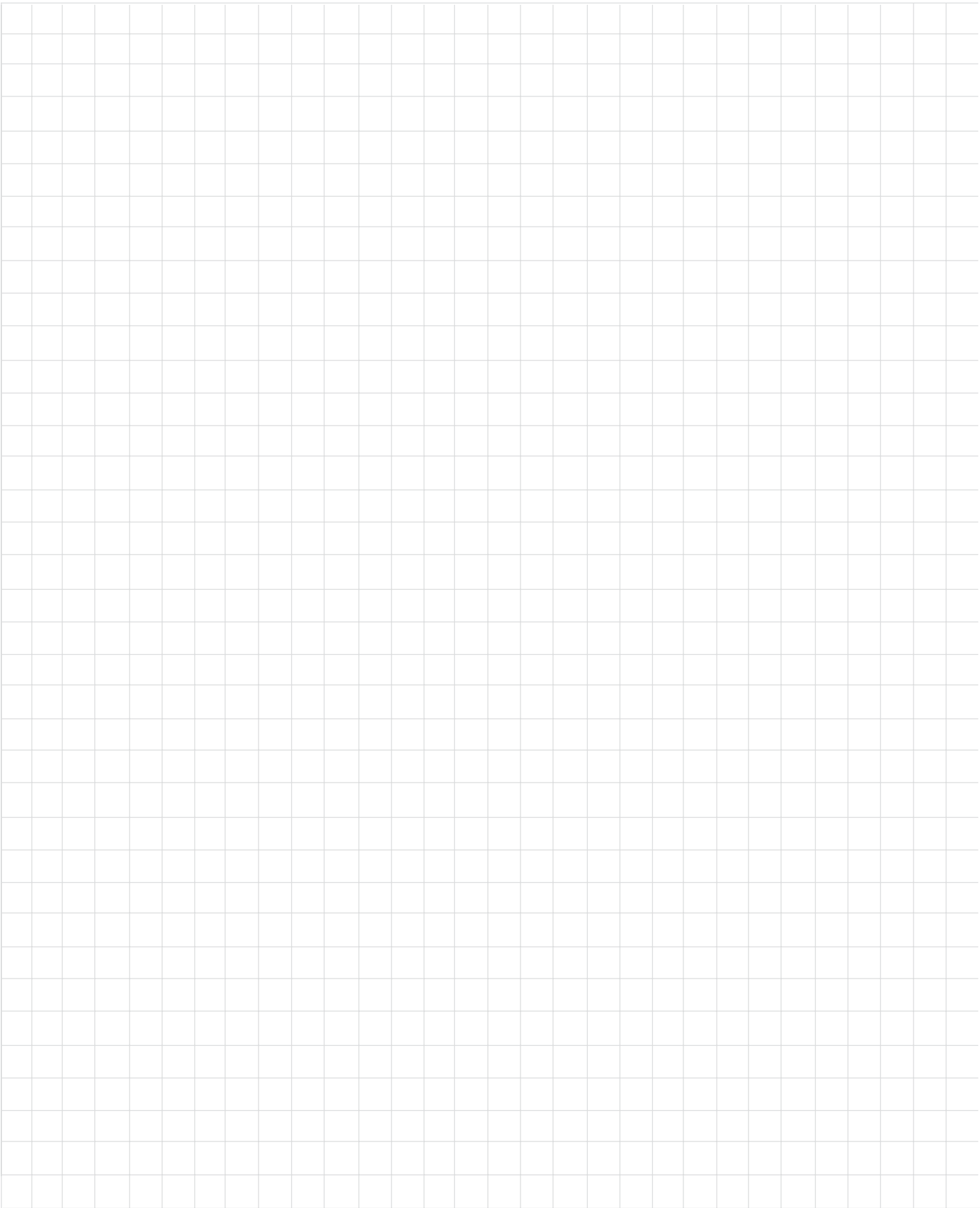

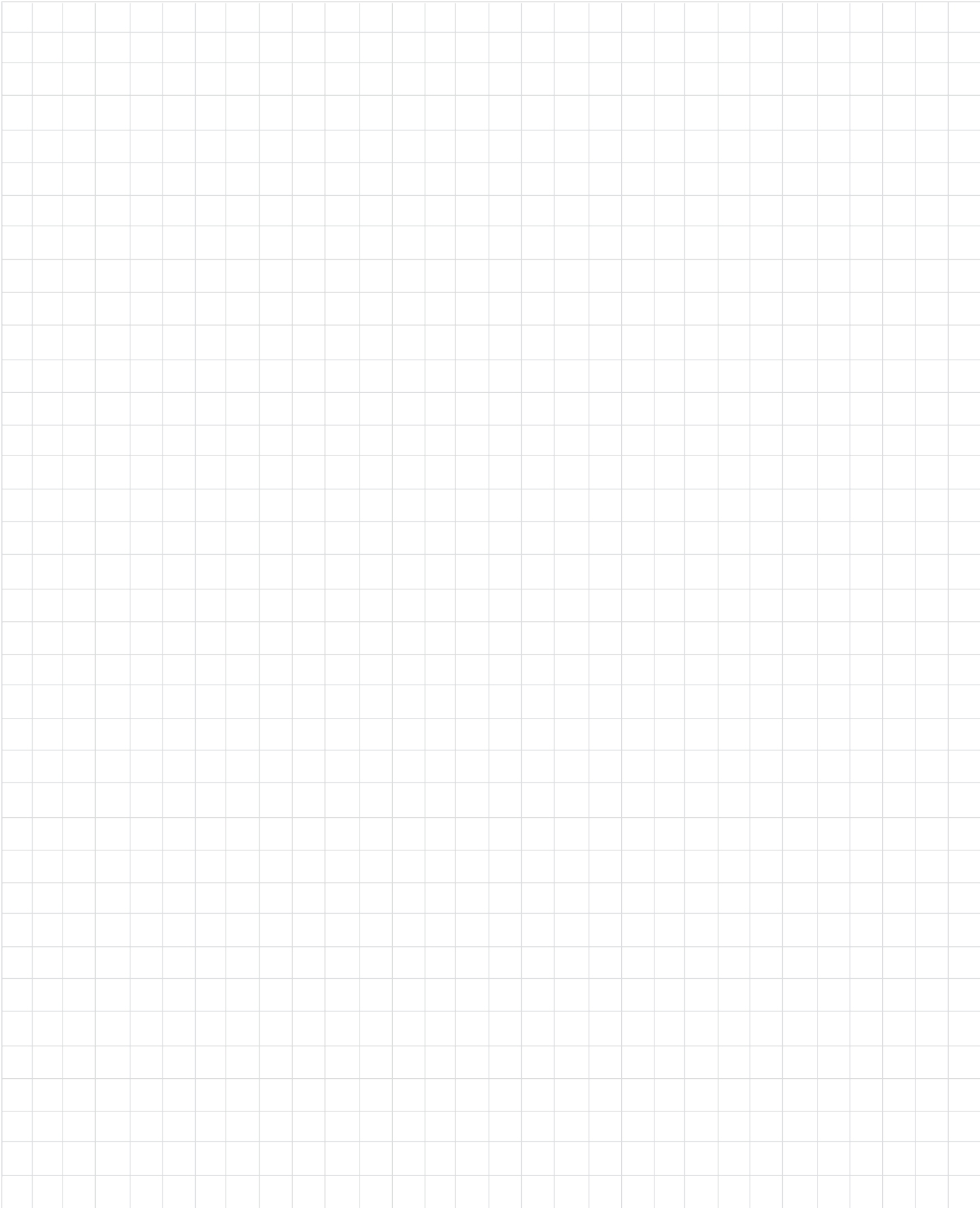

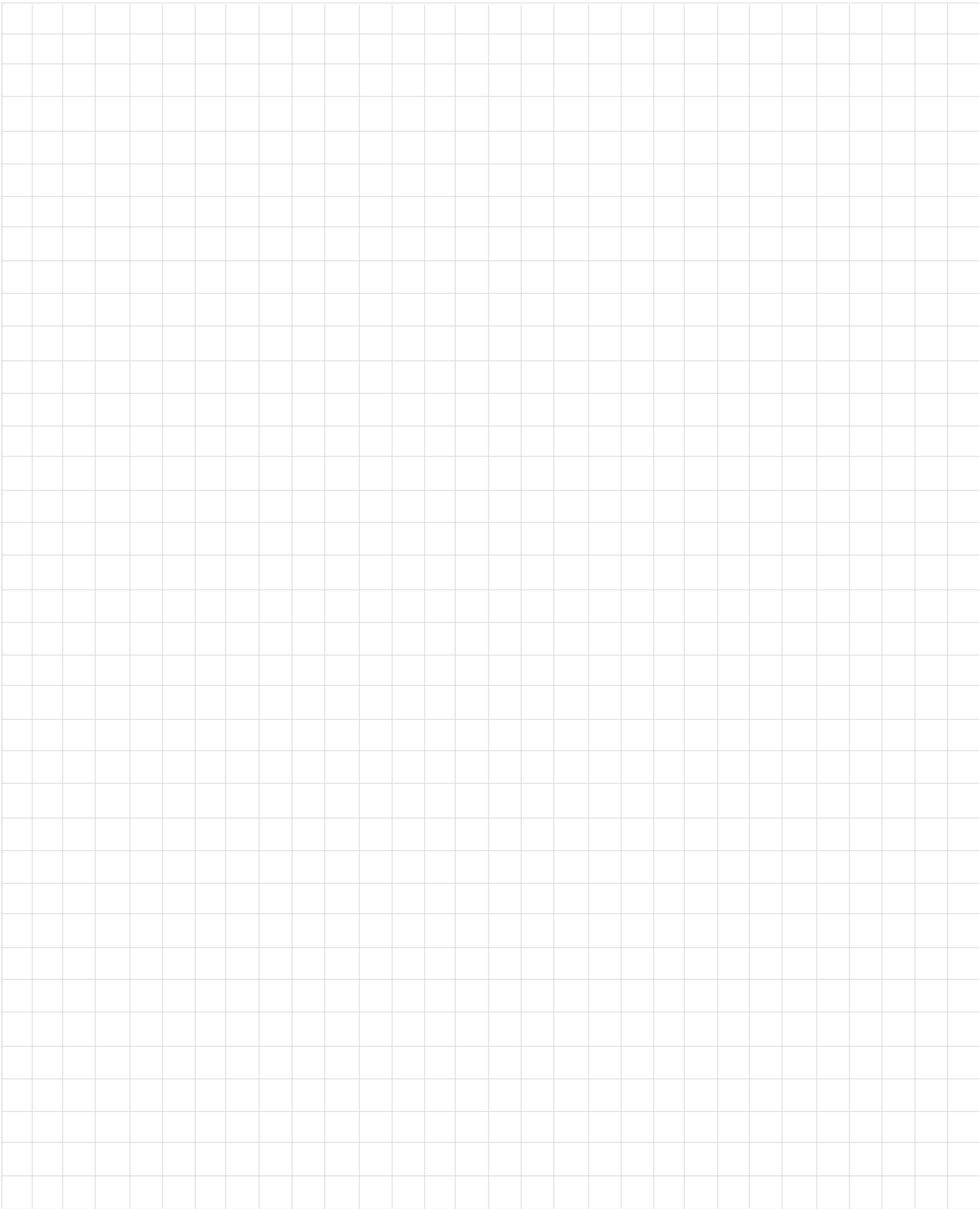

Specifications

Digital Audio Format

IEC958, S/PDIF

Digital Outputs

Optical: -15 ~ -20dBm

Coaxial: 0.5Vp-p @75ohms

XRL: 5V p-p @110 ohms (AES/EBU)

Transport

Pickup: Optical 3-beam laser

Objective Lens Drive System: 2-Dimensional parallel

Laser Type: GaAIAs semiconductor

Laser Beam Wavelength: 780nm

Digital Signal Format

Sampling Frequency: 44.1kHz

Quantization Bit: 16-bit linear/channel

Modulation Code: Eight to Fourteen Modulation

Error Correction: Cross Interleave Reed Solomon

Power Requirements

100 Volts 50/60Hz, 20 watts

110 Volts 50/60Hz, 20 watts

120 Volts 50/60Hz, 20 watts

220 Volts 50/60Hz, 20 watts

230 Volts 50/60Hz, 20 watts

240 Volts 50/60Hz, 20 watts

Note: Refer to the rear panel of the MCD1000 for the correct voltage.

Overall Dimensions

Width is 17-1/2 inches (44.45cm)

Height is 6 inches (15.24cm) including feet

Depth is 16-1/8 inches (40.96cm) including the Front Panel and Knobs

Weight

27.5 pounds (12.47 kg) net, 41.5 pounds (18.83 kg) in shipping carton

Packing Instructions

In the event it is necessary to repack the equipment for shipment, the equipment must be packed exactly as shown below. It is very important that the four plastic feet are attached to the bottom of the equipment. This will ensure the proper equipment location on the bottom pad. Failure to do this will result in shipping damage.

Use the original shipping carton and interior parts only if they are all in good serviceable condition. If a shipping carton or any of the interior part(s) are needed, please call or write Customer Service Department of McIntosh Laboratory. Please see the Part List for the correct part numbers.

Quantity	Part Number	Description
1	034075	Shipping carton only
4	033837	End cap
1	034076	Inside carton only
1	033726	Top pad
1	034255	Bottom pad
1	034077	Inner carton pad
4	017937	Plastic foot
4	100159	#10-32 x 3/4" screw
4	104083	#10-7/16" Flat washer

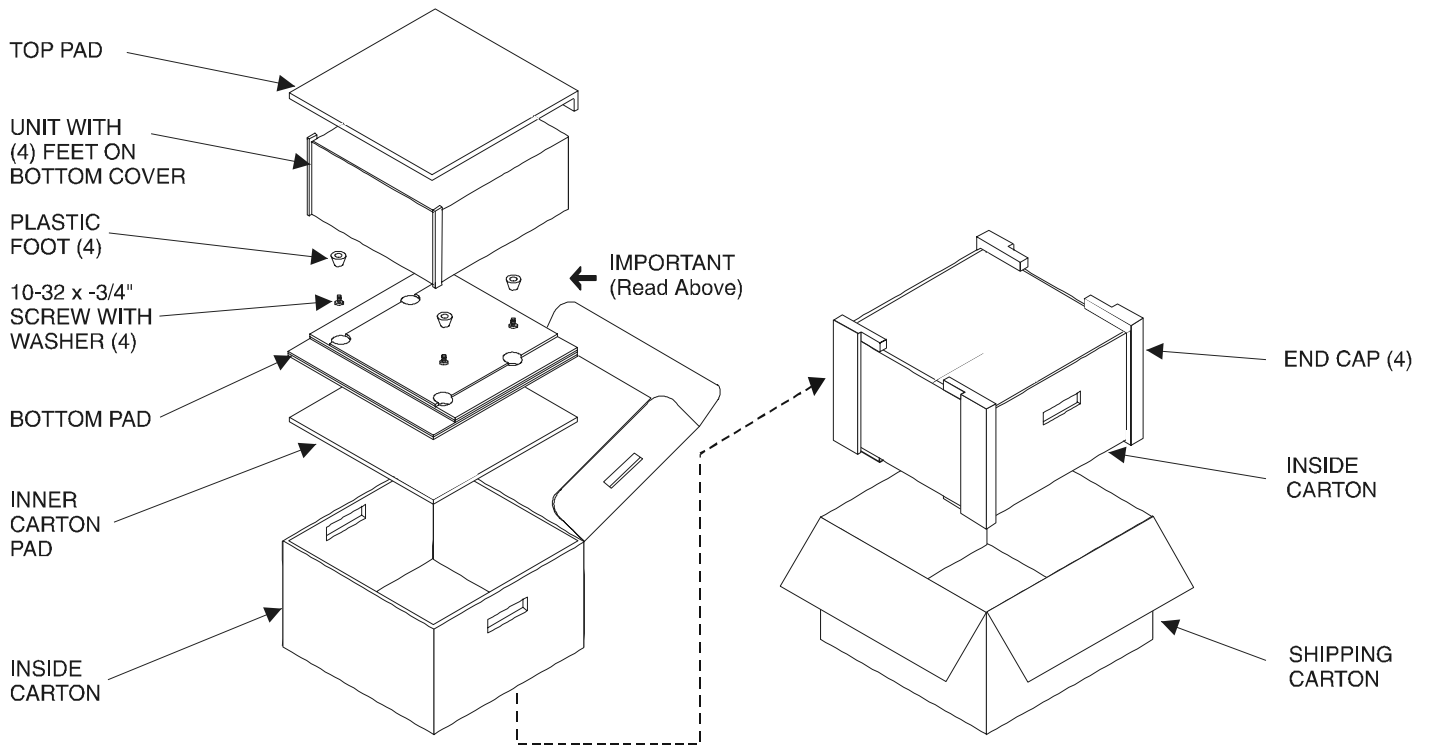



McIntosh Laboratory, Inc.
2 Chambers Street
Binghamton, NY 13903

The continuous improvement of its products is the
policy of McIntosh Laboratory Incorporated who
reserve the right to improve design without notice.
Printed in the U.S.A.

McIntosh Part No. 040889